



942512J

PREDATOR PRO GVT990 GEN W/61" SIDE DISCHARGE

942513J

PREDATOR PRO GVT990 GEN W/72" SIDE DISCHARGE

942514J

PREDATOR PRO FX921V KAW W/61" SIDE DISCHARGE

942515J

PREDATOR PRO FX1000V-DFI KAW W/61" SIDE DISCHARGE

942516J

PREDATOR PRO FX1000V-DFI KAW W/72" SIDE DISCHARGE

942518J

PREDATOR PRO CV750 KOHLER W/72" SIDE DISCHARGE

942519J

PREDATOR PRO FX921V KAW W/72" SIDE DISCHARGE

MAN 4168254
Rev. A 08-2012

PARTS MANUAL 4168253



www.bobcatturf.com

OPERATOR'S MANUAL

CALIFORNIA

Proposition 65 Warning

Diesel engine exhaust and some of its constituents are known to the State of California to cause cancer, birth defects and other reproductive harm.

⚠ WARNING

The engine exhaust from this product contains chemicals known to the State of California to cause cancer, birth defects or other reproductive harm.

Californie Proposition 65 Avertissement

Les échappements des moteurs diesel et certains de leurs composés sont reconnus par l'Etat de Californie pour être cancérigènes, provoquer des défauts congénitaux et d'autres dangers en matière de reproduction.

California Advertencia de la Proposicion 65

⚠ AVERTISSEMENT

L'émission du moteur de ce matériel contient des produits chimiques que l'Etat de Californie considère être cancérigènes, provoquer des défauts congénitaux et d'autres dangers en matière de reproduction.

El estado de California hace saber que los gases de escape de los motores diesel y algunos de sus componentes producen cáncer, defectos de nacimiento y otros daños en el proceso de reproducción humana.

⚠ ADVERTENCIA

El estado de California hace saber que los gases de escape de este producto contienen productos químicos que producen cáncer, defectos de nacimiento y otros daños en el proceso de reproducción humana.

CALIFORNIA

Proposition 65 Warning

Battery posts, terminals, wiring insulation, and related accessories contain lead and lead compounds, chemicals known to the State of California to cause cancer and birth defects or other reproductive harm.

WASH HANDS AFTER HANDLING.

IMPORTANT MESSAGE

Thank you for purchasing this Schiller Grounds Care, Inc. product. You have purchased a world class mowing product, one of the best designed and built anywhere.

This machine comes with an Operation and Safety Manual and a separate Setup, Parts and Maintenance Manual. The useful life and good service you receive from this machine depends to a large extent on how well you read and understand these manuals. Treat your machine properly, lubricate and adjust it as instructed, and it will give you many years of reliable service.

Your safe use of this Schiller Grounds Care, Inc. product is one of our prime design objectives. Many safety features are built in, but we also rely on your good sense and care to achieve accident-free operation. For best protection, study the manuals thoroughly. Learn the proper operation of all controls. Observe all safety precautions. Follow all instructions and warnings completely. Do not remove or defeat any safety features. Make sure those who operate this machine are as well informed and careful in its use as you are.

See a Schiller Grounds Care, Inc. dealer for any service or parts needed. Schiller Grounds Care, Inc. service ensures that you continue to receive the best results possible from Schiller Grounds Care, Inc. products. You can trust Schiller Grounds Care, Inc. replacement parts because they are manufactured with the same high precision and quality as the original parts.

Schiller Grounds Care, Inc. designs and builds its equipment to serve many years in a safe and productive manner. For longest life, use this machine only as directed in the manuals, keep it in good repair and follow safety warnings and instructions. You'll always be glad you did.

Schiller Grounds Care, Inc.
One Bob Cat Lane
Johnson Creek, WI 53038-0469

TABLE OF CONTENTS	PAGE
SAFETY.....	2-8
LABELS.....	9-13
CONTROLS.....	14-17
PRE-OPERATION CHECK LIST.....	18
OPERATION.....	19-21
MAINTENANCE CHART.....	22
MAINTENANCE RECORD.....	23
MAINTENANCE.....	24-30
ADJUSTMENTS.....	31-35
BELT REPLACEMENT.....	36

NOTICE !!!

Unauthorized modifications may present **extreme** safety hazards to operators and bystanders and could also result in product damage.

Schiller Grounds Care, Inc. strongly warns against, rejects and disclaims any modifications, add-on accessories or product alterations that are not designed, developed, tested and approved by Schiller Grounds Care, Inc. Engineering Department. Any Schiller Grounds Care, Inc. product that is altered, modified or changed in any manner not specifically authorized after original manufacture—including the addition of “after-market” accessories or component parts not specifically approved by Schiller Grounds Care, Inc.—will result in the Schiller Grounds Care, Inc. Warranty being voided.

Any and all liability for personal injury and/or property damage caused by any unauthorized modifications, add-on accessories or products not approved by Schiller Grounds Care, Inc. will be considered the responsibility of the individual(s) or company designing and/or making such changes. Schiller Grounds Care, Inc. will vigorously pursue full indemnification and costs from any party responsible for such unauthorized post-manufacture modifications and/or accessories should personal injury and/or property damage result.



This Operator's Manual should be regarded as part of the machine. Suppliers of both new and second-hand machines must make sure that this manual is provided with the machine.



¡LEA EL INSTRUCTIVO!

Si no lee Ingles, pida ayuda a alguien que si lo lea para que le traduzca las medidas de seguridad.

Schiller Grounds Care, Inc.

One Bobcat Lane
Johnson Creek, WI 53038 U.S.A.
Phone: 920-699-2000
Fax: 920-699-3683

MODEL NUMBER

SERIAL NUMBER



This symbol means:
ATTENTION!
BECOME ALERT!

Your safety and the safety of others is involved.

Signal word definitions:

The signal words below are used to identify levels of hazard seriousness. These words appear in this manual and on the safety labels attached to Schiller Grounds Care, Inc. machines. For your safety and the safety of others, read and follow the information given with these signal words and/or the symbol shown above.

DANGER

DANGER indicates an imminently hazardous situation which, if not avoided, **WILL** result in death or serious injury.

WARNING

WARNING indicates a potentially hazardous situation which, if not avoided, **COULD** result in death or serious injury.

CAUTION

CAUTION indicates a potentially hazardous situation which, if not avoided, **MAY** result in minor or moderate injury. It may also be used to alert against unsafe practices or property damage.

CAUTION

CAUTION used without the safety alert symbol indicates a potentially hazardous situation which, if not avoided, **MAY** result in property damage

MODEL NUMBER: This number appears on sales literature, technical manuals and price lists.

SERIAL NUMBER: This number appears only on your mower. It contains the model number followed consecutively by the serial number. Use this number when ordering parts or seeking warranty information.

PREDATOR-PRO SERIES

PREPARING FOR SAFE OPERATION

Operator preparation and training

Read the Operation & Safety Manual

- If an operator or mechanic cannot read English, it is the owner's responsibility to explain this material to them. If any portion of this material is unclear, contact your dealer representative for clarification.
- Become familiar with the safe operation of the equipment, operator controls and safety signs. Be prepared to stop the engine and attachments quickly in an emergency. Do not operate or allow another person to operate this machine if there are any questions about safety.
- All operators and mechanics should be trained. The owner is responsible for training the users.
- Wear appropriate clothing, including long trousers and safety goggles or safety glasses with side shields when operating mower. Do not operate barefoot or wearing open sandals. Long hair, loose clothing or jewelry may get tangled in moving parts.
- Wear hearing protection.
- Never allow underage children, unskilled or improperly trained people to operate this equipment. Local regulations can restrict the age of the operator.
- Data indicates that those operators age 60 years and above are involved in a large percentage of riding mower-related injuries. Those operators should evaluate their ability to operate the riding mower safely enough to protect themselves and others from injury.
- Do not carry passengers, especially small children. They may fall off and be seriously injured.
- Keep warning labels and this operator's manual legible and intact. Replacement labels and manuals are available from the factory.
- Do not operate machine while under the influence of drugs or alcohol.
- The owner/user can prevent and is responsible for accidents or injuries occurring to themselves, other people or property.



Site preparation and circumstances

- Evaluate the terrain to determine what accessories and attachments are needed to properly and safely perform the job. Only use accessories and attachments approved by the manufacturer.
- Clear the area to be mowed of objects such as rocks, toys, wire or other debris that may be picked up or thrown by the mower.
- Be sure the area is clear of pets and people, especially young children. Never assume they will remain where you last saw them. Stop the machine if any enter the area.
- Mow only in daylight or in good artificial light.
- Do not mow wet grass as tires may lose traction.

MACHINE OPERATION

- Check operator present interlock system and brake operation. Adjust or repair any problems before using.
- Do not tamper with or defeat safety devices. Keep guards, shields and interlock safety devices in place and in proper working condition. They are for your protection.
- Keep all fasteners such as nuts, bolts and pins well secured.
- Visually inspect blades, blade bolts and the cutter assembly for wear or damage. Replace worn or damaged blades and bolts to preserve balance.
- Verify that machine and attachments, if any, are in good operating condition.
- Do not engage blades until ready to mow.

OPERATING SAFELY

In general

- Use extra care when loading or unloading the machine onto a trailer or truck.
- Watch out for traffic when near or crossing roadways.
- Do not run the engine in an enclosed area where dangerous carbon monoxide fumes can collect.
- Do not place your foot on the ground while operating the machine.
- Before operating, lower the discharge chute, install the mulcher or put the entire grass catcher in place.
- Keep clear of the discharge opening at all times. Never direct the discharge toward a bystander. Stop operation if someone approaches.
- Keep washout ports and other mower housing service openings closed when mowing.
- Use care when pulling loads or using heavy equipment.
 - Use only approved drawbar hitch points.
 - Limit loads to those you can safely control.
 - Do not turn sharply. Use care when reversing.
 - Use counterweight(s) or wheel weights when suggested in the operator's manual.
- Never leave a machine unattended. Always turn off blades, set parking brake, stop engine and remove keys before dismounting.

Starting

- Start only according to instructions in this manual or on the machine.
- Before attempting to start the engine, make sure:
 - the parking brake is on;
 - the PTO is disengaged;
 - the traction drive is in NEUTRAL.
- When starting the engine, make sure hands and feet are clear of the blades.
- Do not start the machine while standing in front of the discharge chute or with the chute directed at someone.
- Do not engage PTO at full throttle. Throttle to idle or lowest possible engine speed.
- Do not change engine governor settings or overspeed the engine. Operating the engine at excessive speed can increase the hazard of personal injury.

MANEUVERING SAFELY

In general

- Slow down before turning.
- Do not mow in reverse unless absolutely necessary. Always look behind and down for small children and pets before and during backing.
- Be aware when approaching blind corners, shrubs, trees, tall grass or other objects that may obscure vision.
- If tires lose traction, disengage the blades. If on a slope, head down.

PREDATOR-PRO SERIES

Interrupting operation

- Before leaving the operator's position:
 - Park on level ground;
 - Disengage the PTO;
 - Set the parking brake;
 - Shut off the engine and remove the key.
- Disengage the PTO and wait until the blades quit rotating:
 - before raising cutterdeck;
 - when not mowing;
 - for transport;
 - when crossing surfaces other than grass.
- Stop the engine, disengage the PTO and wait until the blades quit rotating:
 - before refueling;
 - before removing grass catcher;
 - before making height adjustment unless the adjustment can be made from the operator's position.
- Stop the engine, disengage the PTO and disconnect the spark plug wire(s) or remove the key:
 - before clearing blockages or unclogging chute;
 - before checking, cleaning or working on the machine;
 - after striking a foreign object. Inspect the machine for damage and make repairs before restarting.
 - if the machine begins to vibrate abnormally: Inspect and make repairs as needed before restarting;
 - except for repairs or adjustments as specifically noted, such as for carburetor adjustment, where the engine must be running. Keep hands and feet clear of moving parts in these circumstances.
- Allow the blades to come to a complete stop when stopping operation to clear blockages, unclog, inspect the machine, do maintenance or repair.
- Reduce the throttle setting during engine shut-down and, if the engine is provided with a shut-off valve, turn the fuel off at the conclusion of mowing.

MOWING SLOPES



Slopes are a major factor in loss-of-control and tipover accidents that sometimes lead to severe injury or death. All slopes require extra caution.

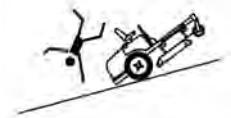

- Do not mow on slopes if uneasy or uncertain. Ultimate responsibility for safe operation on slopes rests with the operator.
- Do not mow excessively steep slopes.
- With ride-on machines, including articulated steering machines, mow up and down slopes, not across, except for zero turn machines. Zero turn machines should mow across slopes.
- With walk-behind machines, always mow across slopes, not up and down.
- Avoid starting or stopping on a slope. If tires lose traction, disengage the blades and proceed slowly straight down the slope.
- With a zero turn machine, if tires lose traction going down a slope, steering control may be regained by speeding up.
- Mid-mount zero turns (belly mounted deck) have much greater traction pointed up slope than down slope. Be aware that traction may be lost going down a slope. Do not operate a mid-mount zero turn on slopes it cannot back up.
- Keep all movement on the slopes slow and gradual. Do not make sudden changes in speed or direction.
- Do not turn on slopes unless necessary, and then turn slowly and downhill when possible.
- Stay away from slopes if the ground is loose or if caught in the rain during mowing.
- Use lower speeds on a slope to avoid stopping or shifting.
- Use extra care with grass catchers or other attachments. These can change the stability of the machine.
- Avoid driving over ruts, holes, rocks and roots whenever possible. Be alert to dips and rises. Uneven terrain can overturn a mower or cause it to slide.
- Do not mow dropoffs, ditches or embankments. The machine could suddenly turn over if a wheel runs over the edge or an edge caves in.
- Follow the manufacturer's recommendations for wheel weights or counterweights to improve stability.

ROLL OVER PROTECTION STRUCTURE (ROPS)

- A folding Rollover Protection Structures (ROPS) is attached on this machine.
- If a ROPS is installed and the machine is overturning, hold onto the steering levers. Do not attempt to jump out or leave the seat. Wear the seatbelt

ROPS in Vertical Position

- The ROPS should be in the vertical position for normal operation. Insure that the seat plate pins are in the lock position. **WEAR** the seatbelt when the ROPS is in the vertical position.

ROPS in Folded Position

- A folding ROPS allows the overall height of the machine to be reduced for increased clearance to get into a low ceiling height trailer or under low hanging branches. **DO NOT** wear the seatbelt when the ROPS is folded. Stop the machine and restore the ROPS to the vertical position as soon as the need for increased clearance is past.

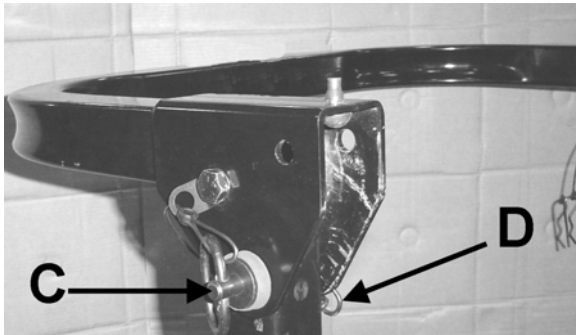

Remove cotter pin **D** from hitch pin **C**. Pull out hitch pin **C**, rotate upper hoop to the upright position. Reinstall hitch pin **C**. Reinstall cotter Pin **D** through hitch pin **C**.

Insure that the lynch pins **L** are securely in the seat plate pin **P**.

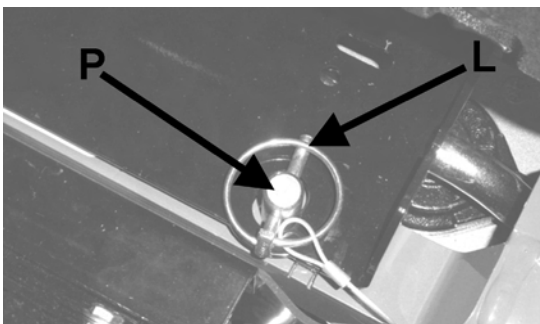

⚠ WARNING

A ROPS is a Roll Over Protective Structure. The ROPS reduces the risk of serious or fatal injury in the unlikely event of a tip over, although the system cannot protect the operator from all possible injuries. It is not designed, made, or intended to provide protection for a machine that is driven off an embankment, retaining wall or similar situation. A ROPS does not replace the need to exercise care when operating on slopes.

IMPORTANT:

- Do not cut, drill, modify or repair a ROPS structure in any manner..
- Always replace a damaged ROPS.
- Keep Roll Bar in the raised position and use the seat belt.
- There is **NO** roll over protection when the roll bar is lowered. Lower the roll bar only when necessary. **DO NOT** remove it. **DO NOT** use the seat belt when the roll bar is in the lowered position. Raise the roll bar as soon as clearance permits.
- Use extreme care when working close to fences, ditches, trees, and on hills.
- Check overhead clearances carefully before driving under any objects.
- DO NOT** leave operator's position while unit is running.
- DO NOT** carry passengers.

	⚠ WARNING SERIOUS INJURY OR DEATH MAY RESULT FROM MACHINE ROLLOVER
	<ul style="list-style-type: none"> • DO NOT OPERATE MACHINE ON STEEP SLOPES OR NEAR DROP OFFS • ALWAYS USE SEAT BELTS WITH ROPS IN RAISED POSITION • AVOID SHARP AND/OR QUICK TURNS • DO NOT EXCEED THE MACHINE WEIGHT RATING OF THE ROPS
⚠ WARNING ROLLOVER MAY CAUSE PERMANENT INJURY OR DEATH.	
<ul style="list-style-type: none"> • ROPS RAISES THE CENTER OF GRAVITY AND REDUCES STABILITY ON SLOPES. • SUDDEN STARTS OR TURNS ON RAMPS OR SLOPES CAN CAUSE OVERTURN. • USE GREATER CARE ON RAMPS AND AS THE SLOPE INCREASES. 	

PREDATOR-PRO SERIES

MAINTENANCE SAFETY

IN GENERAL

- Maintain machine according to manufacturer's schedule and instructions for maximum safety and best mowing results.
- Park machine on level ground.
- Never allow untrained personnel to service machine.
- Adjust or repair only after the engine has been stopped and the blades have stopped rotating.
- Inspect grass catcher components regularly. If worn, damaged or deteriorated, they may expose moving parts or allow objects to be thrown.
- Replace parts if worn, damaged or faulty. For best results, always replace with parts recommended by the manufacturer.
- Disconnect battery or remove spark plug wire(s) before making any repairs. Disconnect the negative terminal first and the positive last. Reconnect positive first and negative last.
- Do not dismantle the machine without releasing or restraining forces which may cause parts to move suddenly.
- Provide adequate support for lifted machine or parts if working beneath.
- Do not put hands or feet near or under rotating parts.
- Clean up oil or fuel spillage thoroughly.
- Replace faulty mufflers.
- To reduce fire hazards, keep the engine, muffler, battery compartment and fuel storage area free of grass, leaves, debris buildup or grease.

BLADES

- Mower blades are sharp and can cut. Use extra caution when handling. Remove obstructions with care. Wrap the blade(s) or wear gloves.
- Be aware that rotating one blade on multiblade mowers can cause other blades to rotate.
- Only replace blades. Never straighten or weld them.
- Keep other persons away from blades.



FUEL



- Gasoline and diesel fuels are flammable; gasoline vapors are explosive. Use extra care when handling.
- Store only in containers specifically designed for fuel.
- When refueling or checking fuel level:
 - Stop the engine and allow to cool;
 - Do not smoke;
 - Refuel outdoors only;
 - Use a funnel;
 - Do not overfill;
 - If fuel is spilled, do not attempt to start the engine until the spill is cleaned up and vapors have cleared.

Sparks from static electricity can start fires or cause explosions. Flowing fuel can generate static electricity. To prevent static electricity sparks:

- Do not fill containers in a vehicle or on a truck or trailer bed with a plastic liner. Fill containers on the ground away from the vehicle.
- When practical, remove gas powered equipment from the truck or trailer and refuel it on the ground. If equipment must be refueled on the truck or trailer, refuel from a portable container rather than a dispenser nozzle.
- Keep the dispenser nozzle in contact with the rim of the fuel tank or container opening until fueling is complete. Do not use a nozzle lock-open device
- Replace caps on fuel cans and tanks securely.

HYDRAULIC SYSTEM

The machine's hydraulic system operates under high pressure.

- When checking for leaks, do not use your hands to attempt to find a leak. Instead, use cardboard or paper.
- Escaping hydraulic fluid can be under sufficient pressure to penetrate skin and cause serious injury.
- If hydraulic fluid is injected into the skin, it must be promptly removed by a doctor familiar with this form of injury or gangrene may result.
- Check that all hydraulic fluid connections are tight and all hydraulic hoses and lines are in good condition before applying pressure to the system.



BATTERY

Battery acid is caustic and fumes are explosive and can cause serious injury or death.

To reduce the risk of personal injury when working near a battery:

- When working with battery acid, use protective equipment such as, but not limited to, goggles, face shield, rubber gloves and apron.
- Avoid leaning over a battery.
- Do not expose a battery to open flames or sparks.
- Be sure batteries with filler caps are properly filled with fluid.
- Do not allow battery acid to contact eyes or skin. Flush any contacted area with water immediately and get medical help.
- Charge batteries in an open, well ventilated area, away from sparks and flames. Unplug charger before connecting or disconnecting from battery.



STORAGE SAFETY

- Stop the engine and allow to cool before storing.
- Drain the fuel tank outdoors only.
- Store fuel in an approved container in a cool, dry place.
- Keep the machine and fuel containers in a locked storage place to prevent tampering and to keep children from playing with them.
- When the machine is to be parked, stored or left unattended, lower the cutterdeck unless a positive mechanical lock is used.
- Do not store the machine or fuel container near heating appliances with an open flame such as a water heater or an appliance with a pilot light.
- Keep gasoline storage area free of grass, leaves and excessive grease to reduce fire hazard.

Jump starting

1. Be sure the jumper cables are in good condition. Turn off the ignition and all electrical accessories on both machines.
2. Position the machine with a good (charged) battery next to but not touching the machine with the dead battery so jumper cables will reach.
3. When making cable connections:
 - make sure the clamps do not touch anywhere except to intended metal parts,
 - Never connect a positive ("+" or red) terminal to a negative ("- " or black) terminal.
 - Make sure the cables won't get caught in any parts after the engines are started.
4. Connect one end of the first jumper cable to the **positive** terminal on one battery. Connect the other end to the **positive** terminal on the other battery.
5. Connect one end of the other cable to the **negative** terminal of the machine with a good (charged) battery. Make the final connection on the engine of the machine to be started, away from the battery.
6. Start the vehicle with the good battery, then the machine with the discharged battery.
7. Remove the cables in the exact reverse order of installation. When removing each clamp, take care it does not touch any other metal parts while the other end remains attached.

PREDATOR-PRO
SERIES

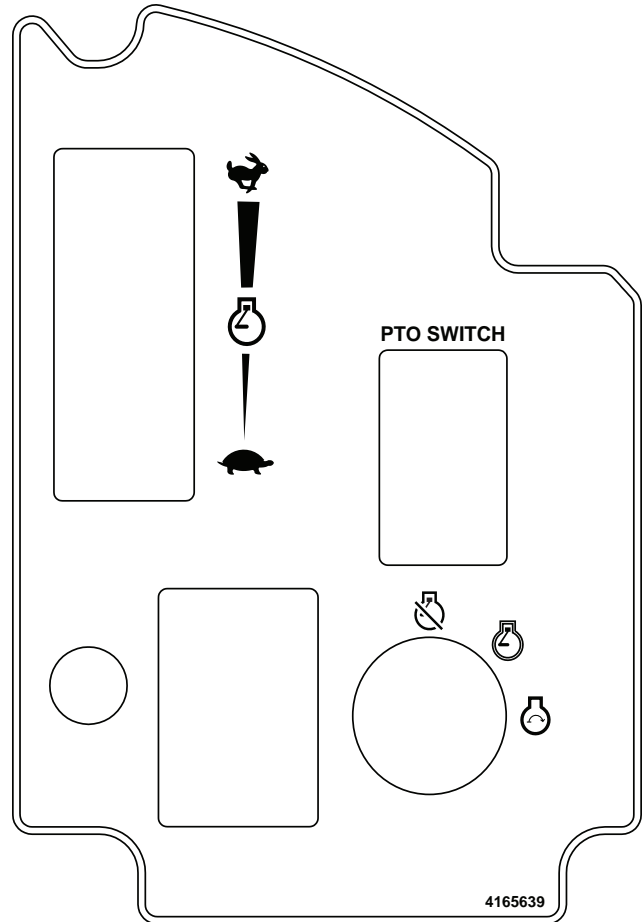
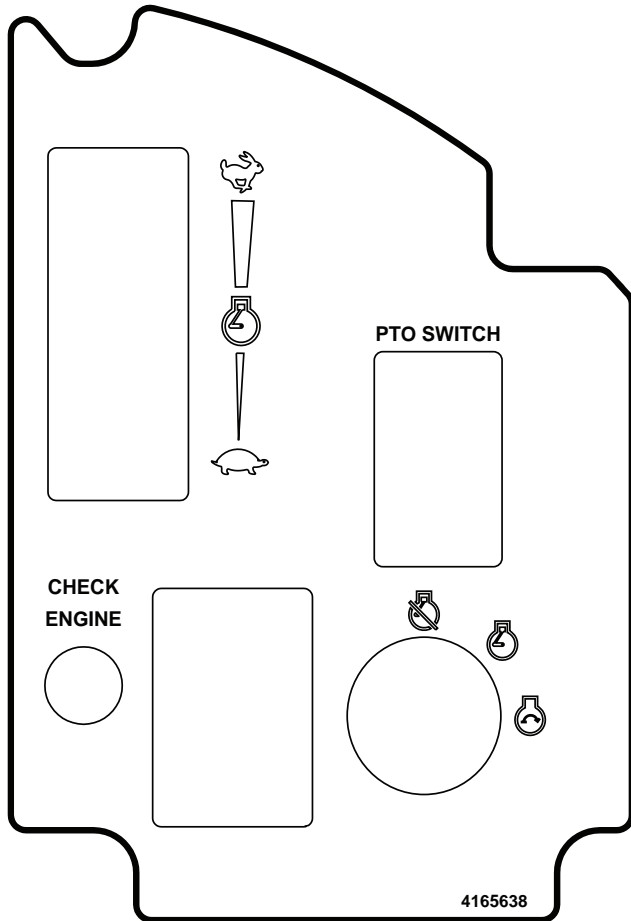

	<p>! DANGER</p> <p>ROTATING BLADES</p> <ul style="list-style-type: none"> - KEEP HANDS AND FEET AWAY - STOP ENGINE AND LET BLADES STOP BEFORE REMOVING GRASS COLLECTOR OR UNCLOGGING.
	<p>! WARNING</p> <p>THROWN OBJECTS</p> <ul style="list-style-type: none"> - KEEP AREA CLEAR OF PEOPLE AND PETS. - REMOVE OBJECTS BLADE MAY STRIKE AND THROW. - STOP BLADES TO CROSS GRAVEL AREAS. - DO NOT OPERATE WITHOUT CHUTE, MULCHER OR ENTIRE GRASS COLLECTOR IN PLACE. <p>4164269</p>



4158401

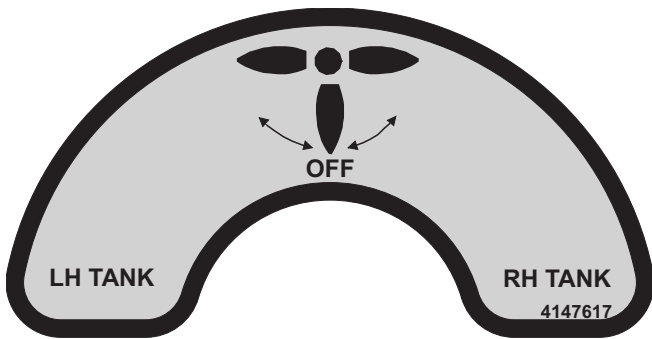

WARNING

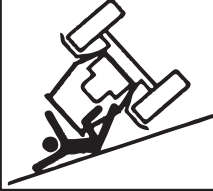

AVOID INJURY OR DEATH FROM ROLL OVER:

- Keep roll bar in the raised position and use seat belt.
- THERE IS NO ROLL OVER PROTECTION WHEN THE ROLL BAR IS LOWERED.
- Lower the roll bar only when necessary and NEVER remove it.
- Do NOT use seat belt when the roll bar is down.
- Raise the roll bar as soon as clearance permits.
- Read and follow all safety instructions and warnings in the operator's manual.

CAUTION

ROLL OVER PROTECTION STRUCTURE

To maintain operator protection and roll bar certification:

- Replace a damaged roll bar. DO NOT attempt to repair or modify.
- Any alteration of the roll bar must be approved by the manufacturer.
- DO NOT exceed the machine weight rating of the roll bar.

PREDATOR-PRO
SERIES

DECK DRIVE BELT ROUTING

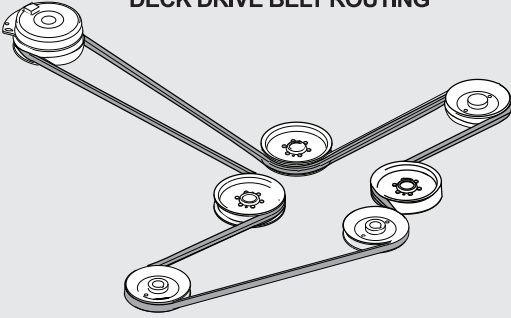

BLADE INSTALLATION

- BELLEVILLE WASHER MUST BE POSITIONED AS SHOWN.
- TORQUE BLADE BOLTS TO 70 FT-LBS.
- SEE OPERATOR'S MANUAL FOR DETAILED BLADE CHANGING PROCEDURE.

TIRE PRESSURE

12 PSI (0.8 KG/CM²)

DECK SIZE	BELT P/N	BLADE P/N
52 IN	4165619	112111-02
61 IN	4165618	112111-03
61 IN GENERAC	4165644	112111-03
72 IN	4165645	112111-07
72 IN GENERAC	4165617	112111-07

4165653

LOCATED UNDER THE FLOOR PLATE

OPERATOR'S MANUAL
IS LOCATED UNDER
THE FOOT PLATE.



4165730

⚠ WARNING

BEFORE STARTING OR SERVICING:



Read and understand the Operator's Manual & labels.

- Be sure machine is in safe operating condition.
- Move traction levers to neutral lock, parking brake to ON.
- Set PTO switch to OFF.

BEFORE LEAVING SEAT:

- Move traction levers to neutral lock, parking brake to ON.
- Set PTO switch to OFF.
- Turn engine keyswitch to OFF.
- Remove key.

⚠ WARNING

AVOID SERIOUS INJURY OR DEATH:

- Read and obey the Operation & Safety Manual.
- Remove objects that could be thrown by the blades.
- Use caution on slopes. Stay off slopes the machine cannot back up.
- Stop blades and drive down slowly if machine slides or stops going on slope.
- Do not mow when children or others are around.
- Do not carry a child or passenger-even with blades off.
- Look down and behind before and while backing.
- Do not operate unless trained.
- Do not operate unless guards, shields and interlocks are in place and working.
- Replace labels and Operation and Safety Manual if lost or damaged.

⚠ WARNING

- Remove debris buildup. Debris under belt cover or near muffler can cause fires.
- Blades continue to rotate for a few seconds after blades are turned off.
- Blades must be at least 1/8" above bottom of housing.
- All blades must be identical. Check blade bolts daily for tightness.
- Inspect for damage after striking a foreign object. Make repairs before restarting operation.
- Find and repair cause of any abnormal vibration.

⚠ ADVERTENCIA

- Leer el manual del operador. No permitir que personas no capacitadas para ello usen la máquina.
- Mantener los protectores en su lugar y sus tornillos debidamente fijados.
- Antes de limpiar, ajustar o reparar este equipo, apagar todos los mandos, aplicar el freno de estacionamiento y apagar el motor.
- Mantener las manos, los pies y la ropa alejados de las piezas en movimiento.
- No conducir como pasajero ni llavar pasajeros en máquinas sin asiento para ello.
- Mantener a las demás personas alejadas durante el funcionamiento de la máquina.
- Si no sabe leer inglés, solicitarle a otra persona que le lea y explique el contenido de las etiquetas y del manual de la máquina.

4165610

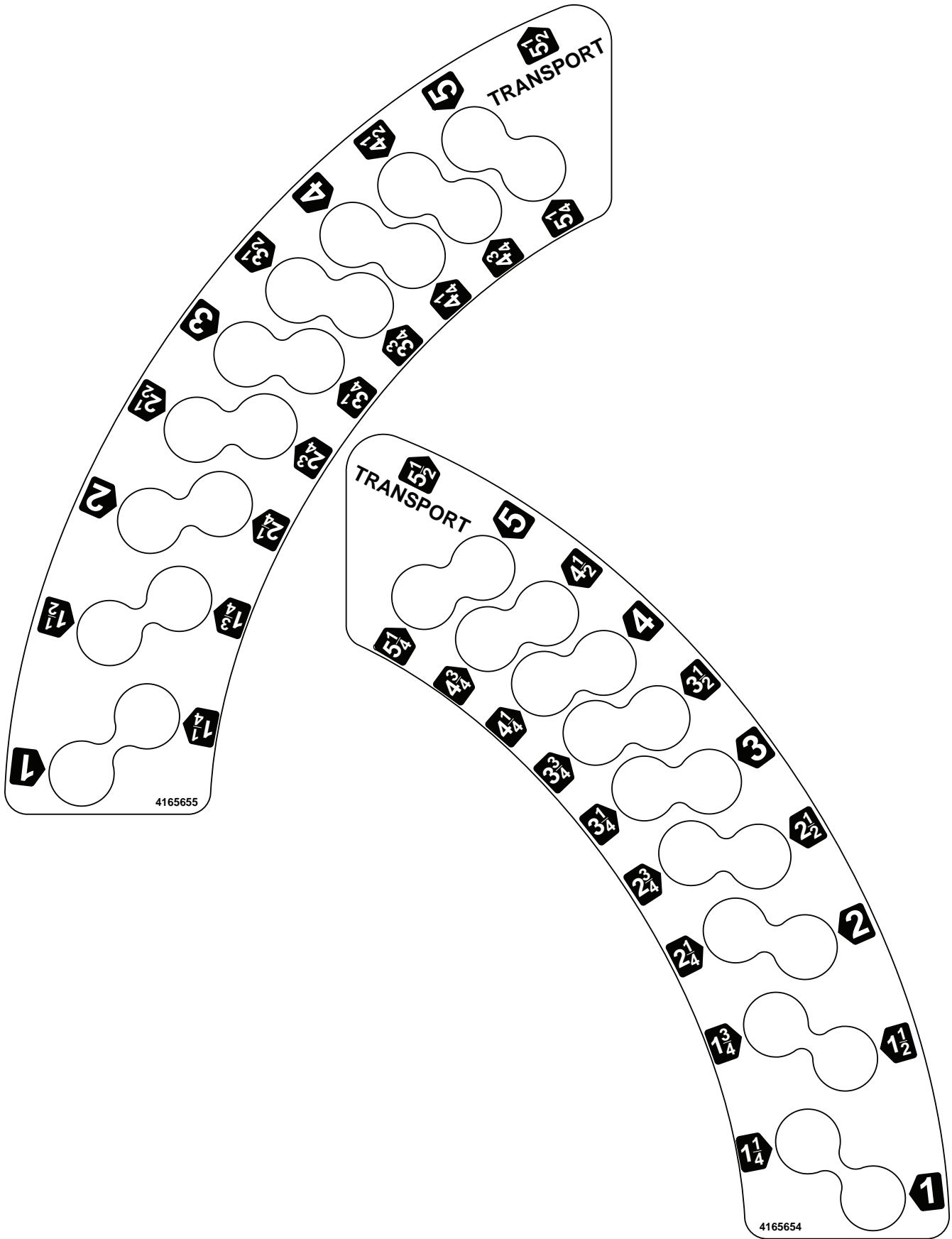

PREDATOR-PRO
SERIES

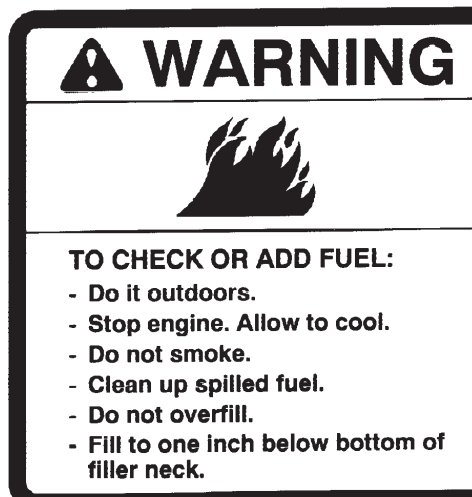
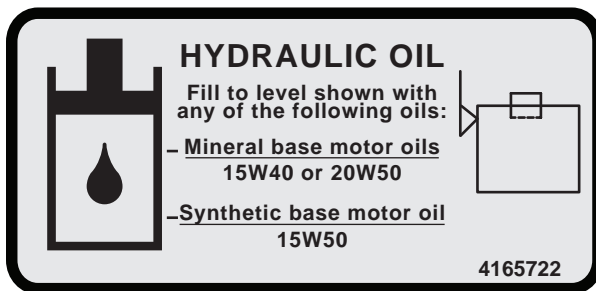
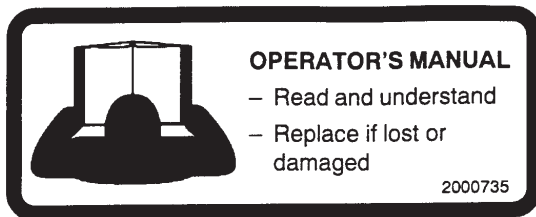
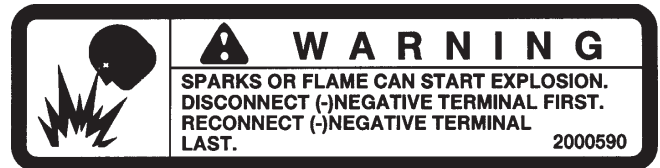
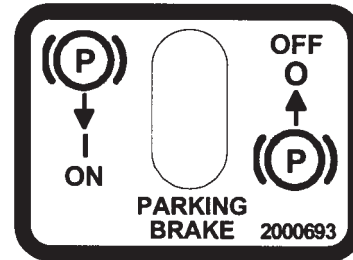
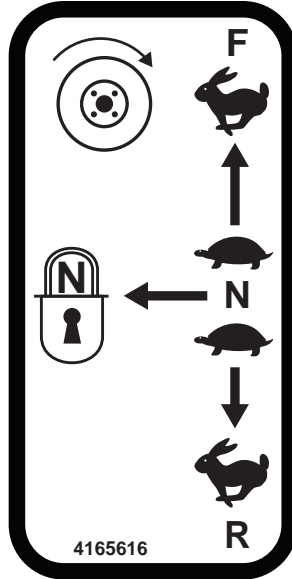
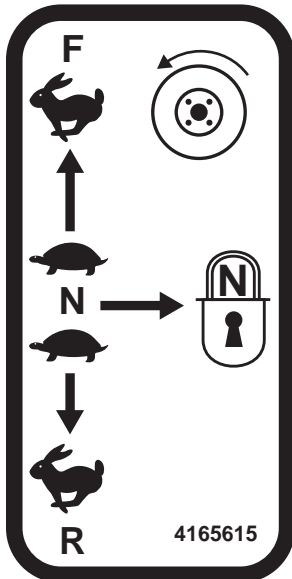

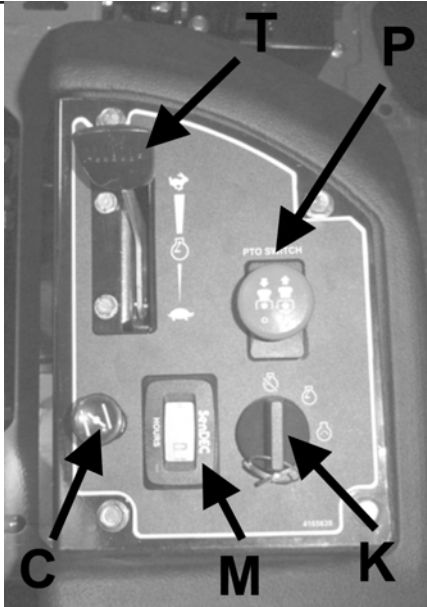

Non DFI operator's right side

THROTTLE (T) - Move the throttle lever forward to increase engine speed until the maximum governed engine RPM is reached. Move the lever rearward to decrease engine speed until the engine reaches its idle speed.

KEYSWITCH (K) - The keyswitch has three positions: OFF, RUN, and START. Insert the key and turn it clockwise to move the switch from OFF to RUN. Turn it further to START and hold to engage the starter. Release the key and the switch will return to RUN from START. Turn the key counterclockwise to OFF to stop the engine. On the Predator Pro DFI models, if either tank runs out of fuel, cycle the keyswitch to the ON or RUN position 2 to 3 times, without cranking, for 10 seconds to prime the fuel system.

CHOKE (C) - Pull the choke control out to set the choke ON. Push it in to set the choke OFF.

ENGINE INDICATOR LIGHT (E) - A check engine light is provided on DFI units for Kawasaki engine dealers to diagnose engine codes. **NOTE:** When starting the engine, the indicator light will come on briefly as an engine system check. If the light continues to blink after initial start-up, shut off engine, insure the battery cables are connected properly and securely, and that the battery is charged properly. Re-start the engine. If the indicator light continues to blink, contact an authorized BobCat dealer.

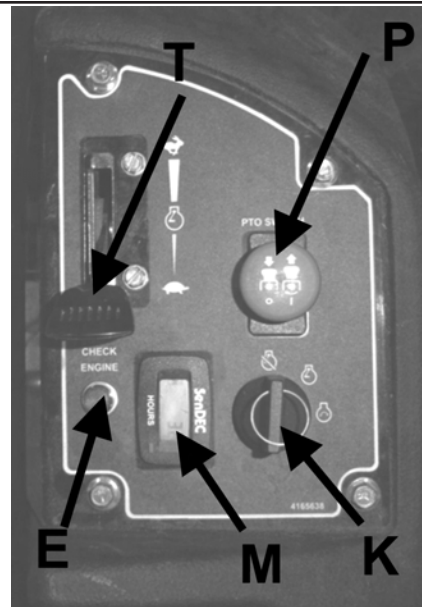

DFI operator's right side

POWER TAKE OFF (PTO) SWITCH (P) - The operator must be in the seat when engaging the PTO or the engine will kill. Pulling the PTO switch out engages (turns on) the PTO and starts the blades or other attachment. Pushing the PTO switch in disengages (turns off) the PTO and stops the blades or other attachment.

NOTE: The PTO switch does not control attachments powered by a separate engine.

- Disengage the PTO whenever you stop or leave the operator's position.
- Shut off engine with the key and remove the spark plug wires before making adjustments or unplugging a clogged mower.
- Do not engage the PTO until ready to start mowing.

HOUR METER (M) - Records accumulated time the machine is in operation and provides service alerts. Push and release MODE button to toggle between functions. Provided service alerts include change engine oil and filter, change hydraulic oil, and service air filter. When the service time is approaching, an alert message will flash temporarily, interrupting whatever mode the meter is in. This will continue until the alert is reset. When the service interval reaches "0" hours, the word "NOW" replaces the hours remaining. To reset the service alert, depress and hold down the mode button for 6 seconds while in the alert to be cleared.

PREDATOR-PRO SERIES

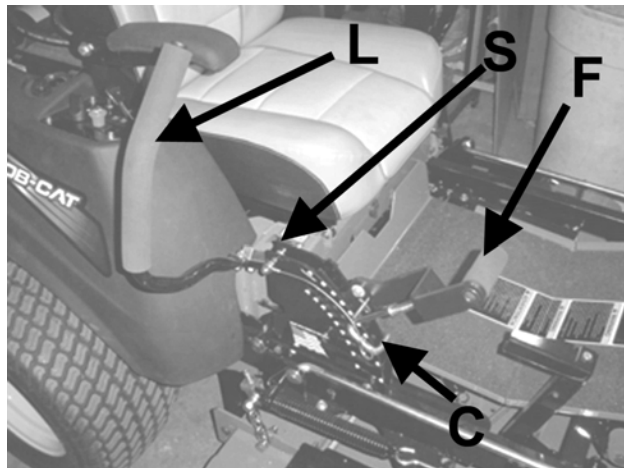

**Lift and traction levers
(operator's right side)**

HEIGHT OF CUT PIN (C) - Sets height of cut and allows easy return from transport to desired height of cut. Raise the deck to transport with the lift lever **F**. Position pin **C** in the hole corresponding to the desired height of cut. Lower the lift lever until it rests on pin **C**.

TRACTION LEVERS (L) - Each of the two traction levers controls the drive wheel located on the same side. They control the forward and reverse movement of the machine, provide steering and also provide dynamic braking.

The operator must be in the seat and the parking brake must be OFF or the traction drive cannot be engaged. To engage traction drive, move the traction levers toward the center of the machine until they are out of neutral lock slot **S**.

Forward movement - To move the machine straight ahead, push both traction levers forward equally from their neutral position. Forward speed increases as the levers are moved farther forward from the neutral position. Maximum forward speed is reached when the levers hit the front of the forward-reverse slot. When traveling forward, pulling the traction levers rearward slows the machine, and the machine stops when the neutral position is reached.

Reverse movement - To move the machine straight back, pull both traction levers back equally from their neutral position. Reverse speed increases as the levers are moved back farther. Maximum reverse speed is reached when the levers hit the rear of the forward-reverse slot. When moving in reverse, pushing the levers forward slows the machine, and the machine stops when the neutral position is reached.

NOTE: Reverse is spring loaded to return to neutral. This spring resistance may be felt when moving the traction levers into reverse. When the levers are released in reverse, spring tension will slowly return them to the neutral position.

STEERING - To steer, move one lever forward and one back.

Turns during forward movement:

- **Right turn** - move the right traction lever back toward neutral to slow the right drive wheel.
- **Left turn** - move the left traction lever back toward neutral to slow the left drive wheel.

Turns during reverse movement:

- **Reverse right turn** - move the right traction lever forward toward neutral to slow the right drive wheel.
- **Reverse left turn** - move the left traction lever forward toward neutral to slow the left drive wheel.

Slow, sweeping turns are made with both traction levers on the same side of neutral and slightly apart. True zero radius turns about the center of the machine are made by having one lever in reverse while the other is in forward. By varying the relative positions of the two levers, the rate of turn is varied to suit the mowing situation.

CAUTION

Slow down before making sharp turns. The machine is capable of turning very rapidly when the levers are moved further apart from each other. Loss of control and/or turf damage may result.

FUEL VALVES (U) - A fuel tank selector valve is provided on oil cooler mounting bracket. The fuel tank selector valve has three positions:

Off: The tank selector is off when the lever points toward the machine. The selector should be off whenever the machine is transported or stands unused for any length of time. Shutting off the fuel supply avoids the possibility of flooding should any dirt get under the carburetor float needle. Leaving the tank selector in either tank position can allow severe flooding, which may ruin the engine by diluting the oil.

Right Tank: Fuel flows from the right tank when the selector is turned 1/4 turn toward the left, when facing the valve.

Left Tank: Fuel flows from the left tank when the selector is turned 1/4 turn toward the right, when facing the valve.

DFI - FULE VALVES (V)-

(942515G - S/N 00288 AND BELOW)

(942516G - S/N 00187 AND BELOW)

A fuel tank selector valve is provided on the left side behind operator's seat.

Off: The tank selector is off when the lever points to the front of the machine. The selector should be off whenever the machine is transported or stands unused for any length of time. Shutting off the fuel supply avoids the possibility of flooding should any dirt get under the carburetor float needle. Leaving the tank selector in either tank position can allow severe flooding, which may ruin the engine by diluting the oil.

Right Tank: Fuel flows from the right tank when the selector is turned 1/4 turn toward the rear of the machine.

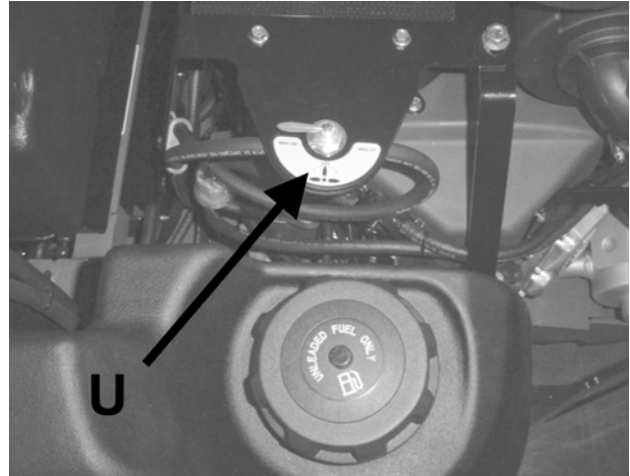

Located on oil cooler bracket behind seat.

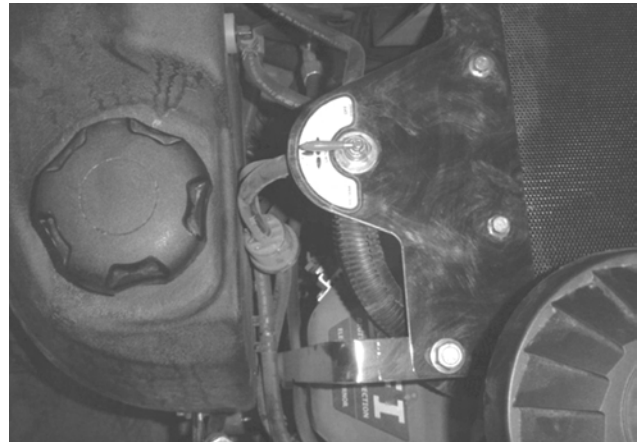

Left Tank: Fuel flows from the left tank when the selector is turned 1/4 turn toward the left hand side of the machine.

12 VOLT POWER OUTLET (X) - A 12 volt power outlet is provided to operate 12 volt personal accessories.

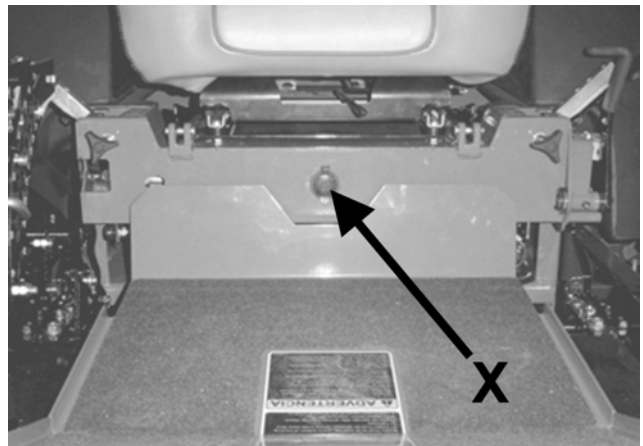

PREDATOR-PRO SERIES

FOOT LIFT PEDAL

The foot lift pedal **A**, allows the operator to raise the mower deck to the highest position without removing his/her hands from the traction controls.

To use the foot lift pedal **A**, press on it to raise the deck. The picture shows the foot lift pedal mounted on the RH side of the machine. If you prefer to have the foot mounted lift pedal on the left hand side, simply loosen the existing hardware and mount the foot lift pedal in a similar manner to the left hand side. Tighten the hardware to secure the foot lift pedal.

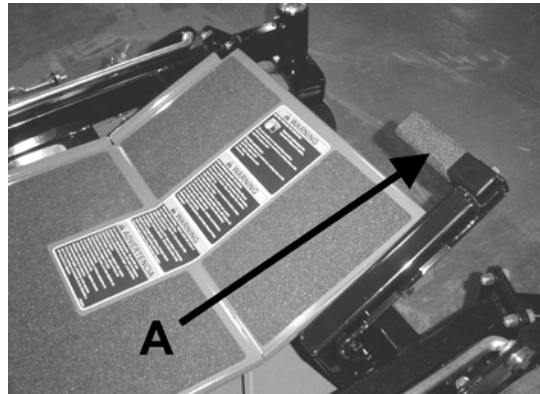

PARKING BRAKE (R) - Pull the parking brake lever up and back to put the parking brake ON. Push it forward and down to put the parking brake OFF.

The parking brake must be ON to start the engine. It must also be ON and the traction levers must be in neutral to keep the engine running if the operator leaves the seat. The parking brake must be OFF to keep the engine running when a traction lever is moved out of neutral lock.

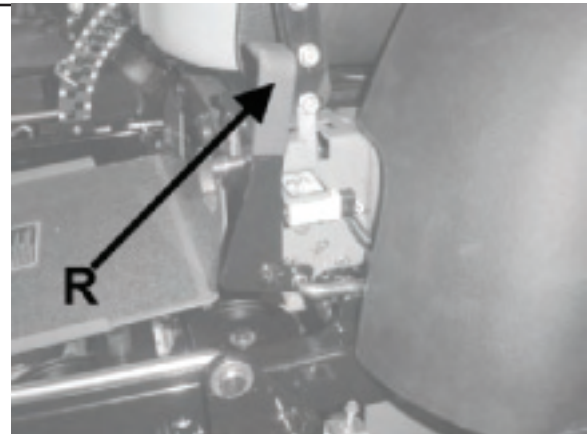

**Parking brake in ON position
(operator's left side)**

PUSHING THE MACHINE

Hydrostat bypass valves (“dump valves”) on each hydrostatic pump allow the machine to be pushed or towed without the engine running. Parking Brake must be off. Raise the seat to gain access to these two valves **V**. Turn both valves counterclockwise 1 turn to release the hydrostatic system. Restore the hydrostatic system by turning the valves clockwise only until they re-seat. **DO NOT** overtighten.

CAUTION

Use caution if it is necessary to tow the machine. With the bypass valves open, the dynamic braking and steering provided by the hydrostats is disabled. Towing should be done only if a disabled machine cannot be repaired where it broke down.

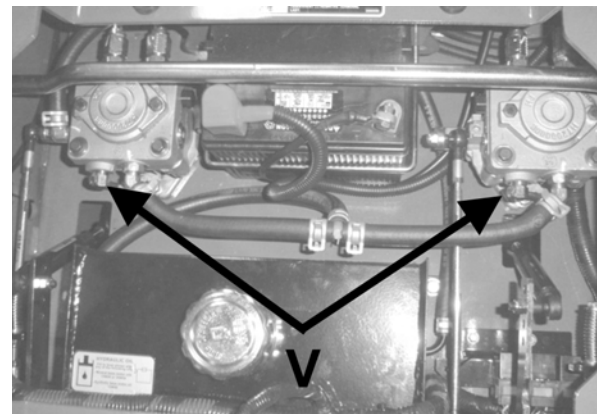

**Compartment beneath the seat,
viewed from above**

PRE-OPERATION CHECK LIST

PREDATOR-PRO
SERIES

PRE-OPERATION CHECK LIST (OWNER'S RESPONSIBILITY)

- | | |
|---|--|
| <ul style="list-style-type: none">___ Review and follow all safety rules and safety decal instructions.___ Check that all safety decals are installed and in good condition. Replace if damaged.___ Check to make sure all shields and guards are properly installed and in good condition. Be sure that either the discharge shield or complete vacuum attachment is installed.___ Check that all hardware is properly installed and secured.___ Check that equipment is properly and securely attached to power unit.___ Check to be sure engine is free of dirt and debris. Pay particular attention to the cooling fins, governor parts and muffler. Clean air intake screen. Check air cleaner; service if necessary. | <ul style="list-style-type: none">___ Never allow riders.___ Inspect area and remove stones, branches or other hard objects that might be thrown, causing injury or damage.___ Clean area around oil fill dipstick. Remove dipstick and check to be sure oil is in operating range (between marks on dipstick). Add oil if necessary but Do Not Overfill. Install dipstick assembly firmly until cap bottoms out on tube. Dipstick assembly must always be secured into fill tube when engine is running.___ Check all lubrication points and grease as instructed in manual.___ Check hydrostatic fluid level. Check to be sure cooling fins on hydrostat are clean.___ Perform a functional check of the safety interlock system each time you operate the unit. |
|---|--|

FUELING

- Fill fuel tanks with good quality, clean, unleaded gasoline. Do not use hi-test fuel.
- Use a funnel to avoid spillage.

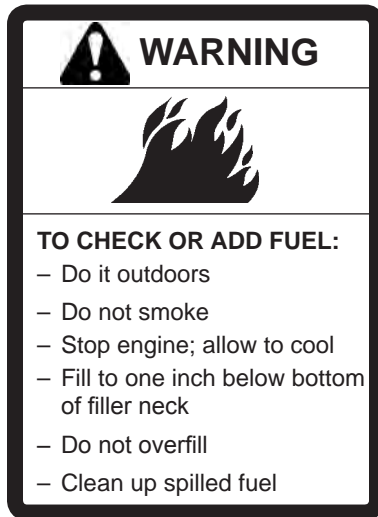
**BEFORE STARTING THE ENGINE**

- Be familiar with all controls, how each functions and what each operates.
- Check the engine oil level and add if necessary. Open the fuel valves under each fuel tank. Select which tank to draw fuel from with the fuel selector valve.
- **Choke:** For cold starts, set the throttle lever to the half-open position and pull the choke out to the ON position. For warm starts set the throttle to the half-open position and the choke to the OFF position.

OPERATOR PRESENCE INTERLOCK SYSTEM

To start the engine:

- The PTO switch must be **OFF**.
- Both traction levers must be in the neutral lock position.
- The parking brake must be **ON**.

To operate the machine:

1. The operator must be in the seat or engaging the PTO will kill the engine.
2. The parking brake must be **OFF** and the operator must be in the seat, or moving a traction lever from the neutral lock position will kill the engine.

STARTING THE ENGINE

1. Turn the key to operate the electric starter to start the engine. Release the key when the engine starts.
2. If the engine does not start immediately, do not crank for more than 10 seconds at a time. Allow 60 seconds for the starter motor to cool down between starting attempts to prevent the starter motor from burning out.
3. If the choke is ON when the engine starts, gradually back it off until the engine runs with no choke at all.

OPERATING NOTES

- Practice at slow engine and travel speeds with the PTO off until fully familiar with the controls.
- For normal cutting the throttle should be set at the full open position. By using the traction levers to speed up or slow down the machine during use, maximum control and cutting efficiency can be maintained.
- Using the machine at less than full throttle in heavy conditions will cause the engine to labor and result in excessive wear to the engine and hydraulic system.

DRIVING

1. With the PTO disengaged, move the parking brake to OFF.
2. Move both traction levers out of neutral lock.
3. Push both traction levers forward evenly to drive forward in a straight line. Pull both traction levers back evenly to drive backward in a straight line.
4. **Steering** - Move one lever forward and one back.

Turns during forward movement:

- **Right turn** - move the right traction lever back toward neutral to slow the right drive wheel.
- **Left turn** - move the left traction lever back toward neutral to slow the left drive wheel.

Turns during reverse movement:

- **Reverse right turn** - move the right traction lever forward toward neutral to slow the right drive wheel.
- **Reverse left turn** - move the left traction lever forward toward neutral to slow the left drive wheel.

CAUTION

Use caution when making turns. Slow down before making sharp turns to help maintain control and to prevent torn turf from skidding or spinning tires. To help prevent turf damage, keep both drive tires moving whenever a turn is made.

TIP: The best way to make a sharp "zero" turn is to come to a stop, get the machine moving in reverse with both drive wheels and then powering the machine around with the outside wheel. This technique keeps the drive tires turning and results in less turf damage.

	WARNING SERIOUS INJURY OR DEATH MAY RESULT FROM MACHINE ROLLOVER
	<ul style="list-style-type: none">• DO NOT OPERATE MACHINE ON STEEP SLOPES OR NEAR DROP OFFS• ALWAYS USE SEAT BELTS WITH ROPS IN RAISED POSITION• AVOID SHARP AND/OR QUICK TURNS• DO NOT EXCEED THE MACHINE WEIGHT RATING OF THE ROPS
WARNING ROLLOVER MAY CAUSE PERMANENT INJURY OR DEATH. <ul style="list-style-type: none">• ROPS RAISES THE CENTER OF GRAVITY AND REDUCES STABILITY ON SLOPES.• SUDDEN STARTS OR TURNS ON RAMPS OR SLOPES CAN CAUSE OVERTURN.• USE GREATER CARE ON RAMPS AND AS THE SLOPE INCREASES.	

PREDATOR-PRO SERIES

CUTTING

1. Place the discharge chute in the down position or correctly fit a grass collector or mulcher plate.
2. Sit in the seat.
3. Start the engine.
4. Turn the blades on by pulling up on the PTO switch. Do not start the blades at full throttle. Instead, use the slowest throttle setting that will allow the engine to pick up the blade load to reduce the wear on the belts and electric clutch.
5. After the blades are rotating, set the throttle to maximum. Use the traction levers to obtain the required cutting speed, to steer around obstacles and to turn at the end of a cut.

CUTTING TIPS

- When mowing large areas, start by turning to the right so that clippings will be discharged away from shrubs, fences, driveways, etc. After two or three rounds, mow in the opposite direction, left hand turns, until finished.
- If grass is extremely tall, it should be mowed twice, the first cut relatively high, the second cut to the desired height.
- Use the left side of the mower for trimming.
- Choose cutting directions so that clippings are thrown onto areas that already have been cut. This method results in the most even distribution of clippings and more uniform, better appearing cuts.
- Use a different mowing pattern each time a property is cut where possible. This helps prevent rutting and leads to a more uniform cut by keeping the grass from always laying the same way.

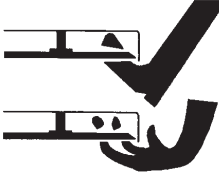
	<p>! DANGER</p> <p>ROTATING BLADES</p> <ul style="list-style-type: none"> – KEEP HANDS AND FEET AWAY. – STOP ENGINE AND LET BLADES STOP BEFORE REMOVING GRASS COLLECTOR OR UNCLOGGING.
--	--

	<p>! WARNING</p> <p>THROWN OBJECTS</p> <ul style="list-style-type: none"> – KEEP AREA CLEAR OF PEOPLE AND PETS. – REMOVE OBJECTS BLADE MAY STRIKE AND THROW. – STOP BLADES TO CROSS GRAVEL AREAS – DO NOT OPERATE WITHOUT CHUTE, MULCHER OR ENTIRE GRASS COLLECTOR IN PLACE.
---	--

MAINTENANCE CHART

**PREDATOR-PRO
SERIES**

MAINTENANCE OPERATION	Maintenance is an ongoing job. These intervals are maximum times between maintenance operations. Perform more often under severe conditions.						
	FIRST 5 HOURS	DAILY	EVERY 25 HOURS	EVERY 50 HOURS	EVERY 100 HOURS	EVERY 200 HOURS	EVERY 500 HOURS
ENGINE							
Consult the engine manual for additional information and instructions							
Check/Top Off Engine Coolant Level (Where Applicable)		X					
Check/Top Off Oil Level		X					
Check For Leaks		X					
Clean Air Intake Screen		X					
Clean Air Cleaner Precleaner			X*				
Clean Air Cleaner Element					X	X**	
Clean Cooling Fins					X		
Change Oil And Filter	X	See engine manufacturer's manual					
Check/Replace Spark Plugs						X	
* N/A IF EQUIPPED WITH HEAVY DUTY CYCLONIC AIR CLEANER **IF EQUIPPED WITH HEAVY DUTY CYCLONIC AIR CLEANER							
HYDRAULICS							
Check For Leaks		X					
Check/Top Off Oil Level					X		
Change Oil And Filter	X						X
MACHINE							
Check Interlock Operation		X					
Check Tire Pressures		X					
Check/Top Off Battery					X		
Lubricate All Points						X	X

PREDATOR-PRO
SERIES

NOTES

GENERAL	DATE	HRS	DATE	HRS	DATE	HRS	DATE	HRS	DATE	HRS	DATE	HRS
	Check Tire Pressures											
Lubricate All Points												
Check Nuts & Bolts												
ENGINE												
Check Engine Coolant Level (Where Applicable)												
Check Oil Level												
Change Oil												
Clean Air Cleaner Element												
Clean Cooling Fins												
Replace Air Cleaner Element												
Clean & Gap Spark Plugs												
NOTE: After first 5 hours of operation replace engine oil, hydraulic oil and both filters.												

CHECK DAILY

Operator Presence Interlock System - Start Operation

For the engine to crank, the parking brake must be on, the PTO (blades) off and traction levers in the neutral lock position. Sit in the seat and check, one by one, if the engine will crank with the parking brake off, the blades on, and either traction lever out of neutral lock.

Operator Presence Interlock System - Run Operation

The operator must be in the seat for the engine to run with the parking brake off, the traction levers moved out of the neutral lock position, or the blades on. To check:

1. Start the engine and run at 1/2 throttle with the operator on the machine but raised off the seat.
2. One by one: move the parking brake to the OFF position, traction levers out of the neutral lock position (check each independently), and turn the blades on. Each check should kill the engine after 1/2 second. (A 1/2 second delay is built into the system to prevent engine cutout when traversing rough terrain.)

Repair machine before using if the Operator Presence Interlock System does not operate correctly in start or run. Contact your authorized Schiller Grounds Care, Inc. dealer.

Hardware

Tighten any nuts and bolts found loose. Replace any broken or missing cotter pins. Repair any other problems before operating.

Tire pressure

Tires should be kept inflated at 12 lbs/in² (0.8 kg/cm²). Improper tire inflation can cause rapid tire wear and poor traction. Uneven inflation can cause uneven cutting.

BATTERY

 **WARNING** Battery acid is caustic and fumes are explosive and can cause serious injury or death.

Use insulated tools, wear protective glasses or goggles and protective clothing when working with batteries. Read and obey the battery manufacturer's instructions.

Be certain the ignition switch is OFF and the key has been removed before servicing the battery.

1. Verify battery polarity before connecting or disconnecting the battery cables.
2. When installing the battery, always assemble the RED, positive (+) battery cable first and the ground, BLACK, negative (-) cable last.
3. When removing the battery, always remove the ground, negative (-) cable first and the red, positive (+) cable last.

4. Check the electrolyte level every 100 hours of operation.
5. Clean the cable ends and battery posts with steel wool. Use a solution of baking soda and water to clean the battery. Do not allow the solution to enter into the battery cells.
6. Tighten cables securely to battery terminals and apply a light coat of silicone dielectric grease to terminals and cable ends to prevent corrosion. Keep terminal covers in place.

PREDATOR-PRO SERIES

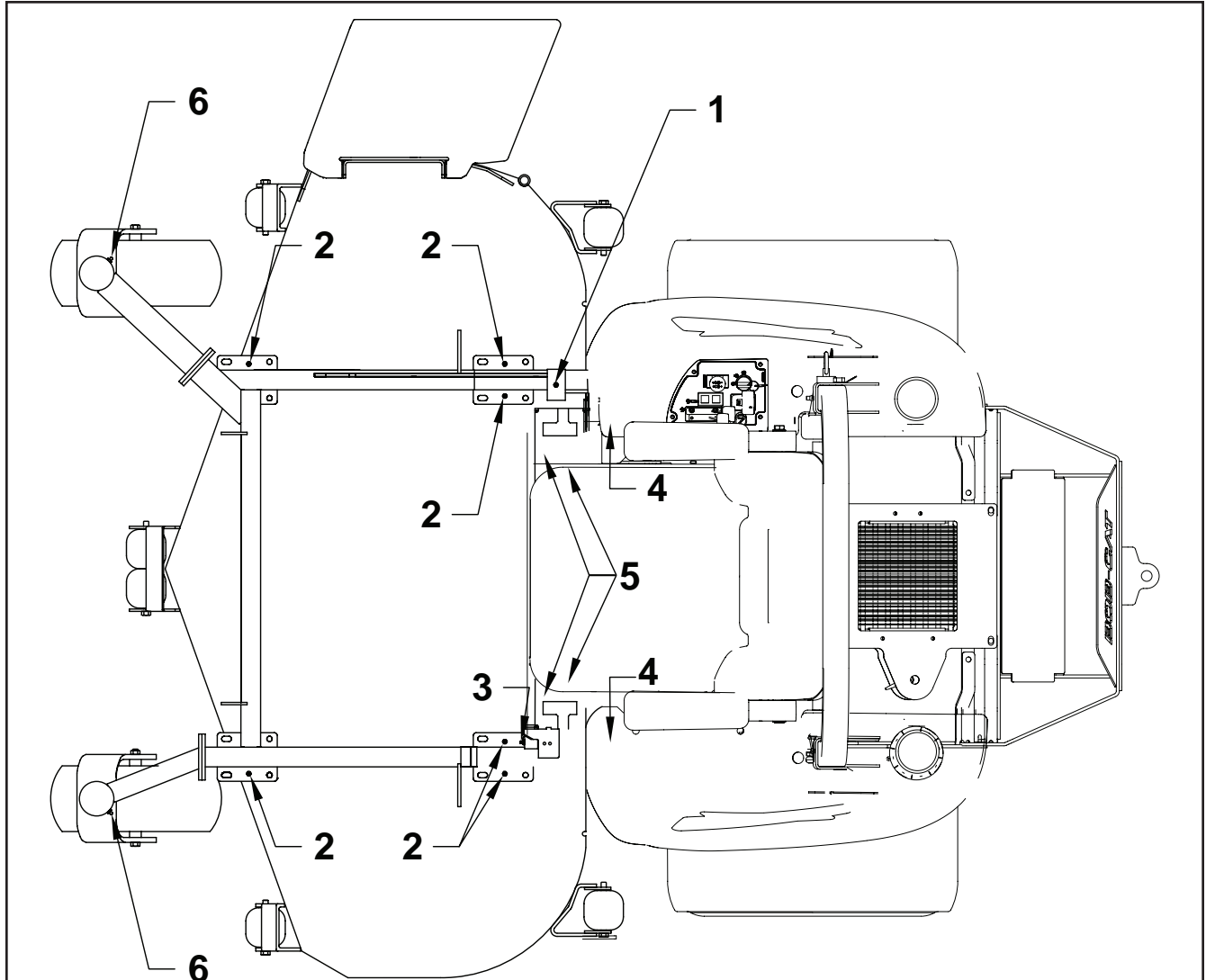

LUBRICATION

Every 50 hours of operation, lubricate the following points (1-4) with grease:

1. Deck lift rockshaft (1 point)
2. Deck lift pivots (6 points)
3. Brake lever pivot (1 point)
4. Push arms (2 points located at rear of cutterdeck under each fuel tank)
5. Isolation mounts (4 points located under seat at front of machine)
6. Caster wheel pivots (2 points)
(Lubricate every 500 hours or once a year)

NOTE ON BLADE SPINDLES - The blade spindles on these machines use a superior sealed bearing that does not require relubrication.

HYDRAULIC SYSTEM

Fluid level in the hydraulic system should be checked after the first 5 hours of operation, and every 100 hours thereafter, or when a leak has occurred. If the fluid is low, check all components for leaks.

To check, remove reservoir cap **M**. The fluid level should be at the bottom of the filler tube. If low, top up (do not overfill). Use one of the oils listed below:

- SAE 15W40 motor oil
- SAE 20W50 motor oil
- 15W50 synthetic motor oil

AFTER FIRST FIVE (5) HOURS

1. Remove plug **N** to drain hydraulic reservoir. Dispose of used oil in accordance with local requirements.
2. Clean and replace the plug.
3. Change hydraulic oil filter **G**.
4. Fill the reservoir with fresh oil to the bottom of the reservoir filler tube, using an oil from the list above. Do not overfill.

PERIODIC OIL CHANGES

Change the hydraulic fluid and hydraulic filter after each 500 hours of operation using the same procedure given above.

NOTES:

Before servicing the hydraulic system, stop the engine, disconnect spark plug wires and disengage the PTO.

- After any hydraulic line is opened, plug or cap it promptly to reduce the risk of contamination.
- Do not use sealant tape on hydraulic pipe fittings. Use a liquid sealant that will dissolve into the system.
- Make sure all hydraulic connections are tight and hydraulic hoses and lines are in good condition before applying pressure to system.

⚠ WARNING

The machine's hydraulic system operates under high pressure. When checking for leaks, do not use your hands to attempt to find a leak. Instead, use cardboard or paper. Escaping hydraulic fluid can be under sufficient pressure to penetrate skin and cause serious injury. If hydraulic fluid is injected into the skin, it must be promptly removed by a doctor familiar with this form of injury or gangrene may result.

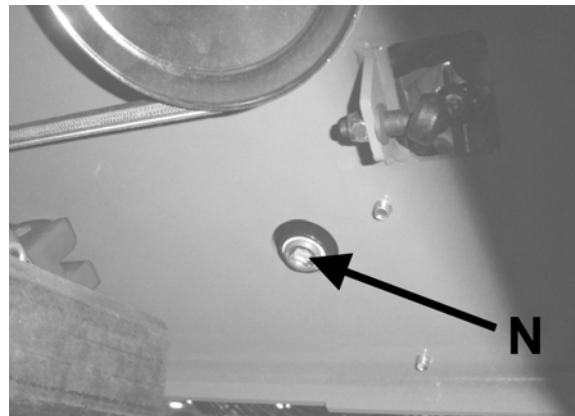
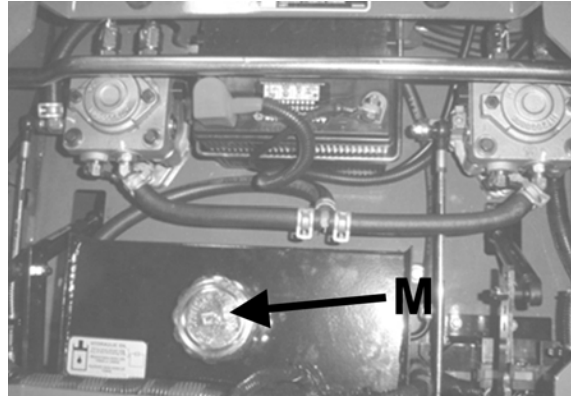

View from below machine

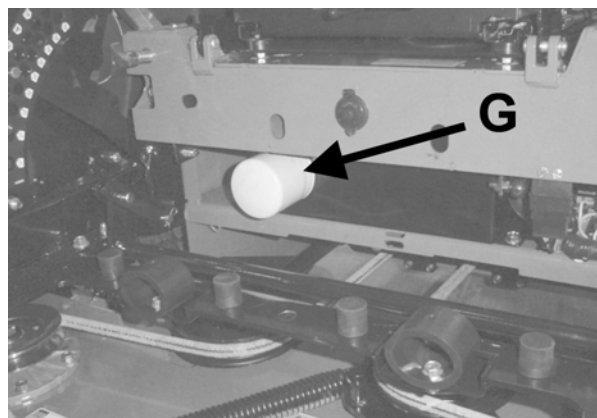

PREDATOR-PRO SERIES

ENGINE OIL

Do not perform engine maintenance without the engine off, spark plug wires disconnected and PTO disengaged.

AFTER FIRST FIVE (5) HOURS

While the engine is warm:

1. Release the oil drain hose assembly from the engine clip **J**. Lay hose assembly over the frame edge.
2. Remove the rubber cap **D** from the tip of the hose assembly and turn the drain valve to allow oil to drain from the engine. Dispose of used oil in accordance with local requirements.
3. Clean drain valve and tighten the plastic portion of the drain valve back into the metal portion of the valve. Replace rubber cap over the tip of the valve. Replace hose assembly back into engine clip.
4. Change oil filter.
5. Fill the crankcase with fresh oil to the full mark. Do not overfill. See engine manual for oil specifications.

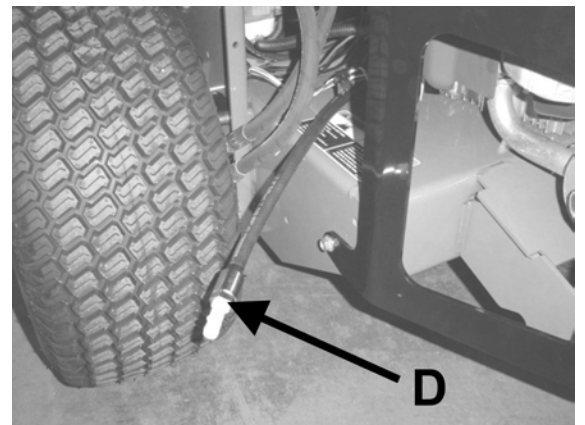
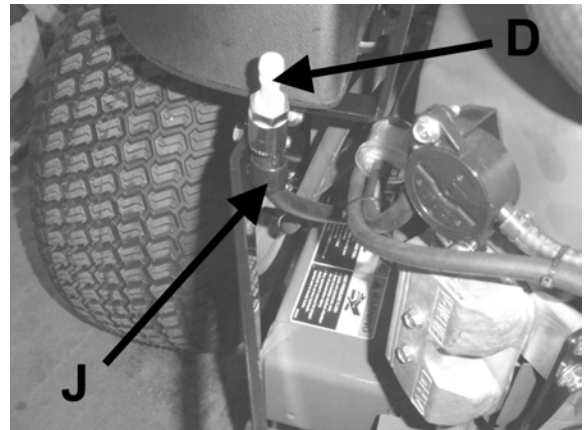

DAILY

1. Check oil level with the dipstick.
2. If oil is needed, add fresh oil of proper viscosity and grade. See engine manual for oil specifications. Do not overfill.
3. Replace dipstick before starting engine.

PERIODIC OIL CHANGES

1. See engine manual for oil and filter change intervals after the break-in period.
2. Follow instructions for first oil change, above.

SPARK PLUGS

Remove each plug and check condition.

- Good operating conditions are indicated if the plug has a light coating of grey or tan deposit.
- A white blistered coating indicates overheating. A black coating indicates an “over rich” fuel mixture. Both may be caused by a clogged air cleaner or improper carburetor adjustment.
- Do not sandblast, wire brush or otherwise attempt to repair a plug in poor condition. Best results are obtained with a new plug.
- Set plug gap as specified in engine manual..

FUEL FILTER

An inline fuel filter is located in the fuel supply line. Inspect at every oil change to make sure it is clean and unobstructed. Replace if dirty.

ENGINE COOLING

Continued operation with a clogged cooling system will cause severe overheating and can result in engine damage.

- **Daily:** Clean air intake screen **S** on air cooled engines.
- **Every 100 hours:** Clean cooling fins beneath blower housing **H** with reference to information in the engine manufacturer's manual.

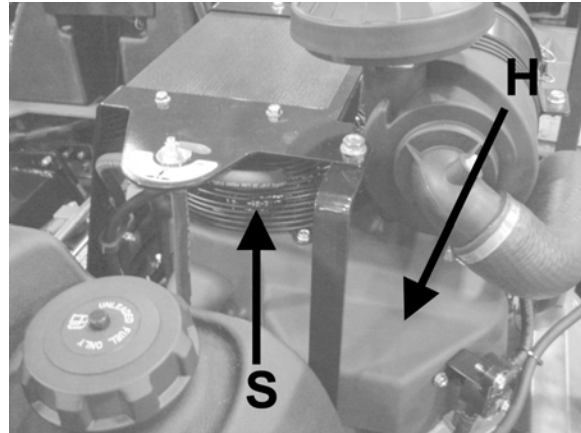

HEAVY DUTY CYCLONIC AIR CLEANER

Clean and replace the air cleaner element as specified in the service chart. Uneven running, lack of power or black exhaust fumes may indicate a dirty air cleaner.

To replace air cleaner elements:

1. Unclamp end cover **X** and remove existing cleaner elements.
2. Insert new elements **Y** and **Z** and replace cover. Ensure the breathing port **A** is pointing down and towards the front of the tractor.

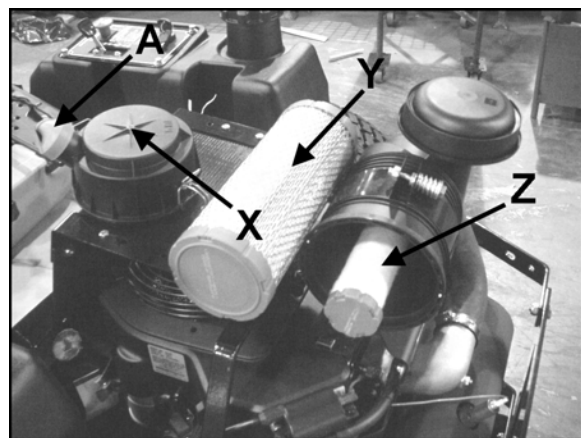

PREDATOR-PRO SERIES

CLEANING MACHINE

Clean the machine after use. The machine will run cooler and last longer if kept free of clippings and other debris. A clean machine also reduces the risk of fire due to accumulation of combustible debris and chaff

Brush or blow clippings and debris off the cutterdeck and engine deck.

WASHING MACHINE

CAUTION: Improperly washing a machine can cause water to enter bearings and other components. This can greatly reduce component life.

- Do not use a pressure washer. Do not direct water at bearings or seals. High pressure water can blow past seals and enter seal bearings.
- Allow the machine to cool down before washing. Water on a warm machine can be sucked into sealed bearings as they cool.
- Avoid getting electrical connections wet. Water can cause electrical faults and corrosion of electrical components.

BLADE REMOVAL

Follow these instructions to prevent injury during blade removal:

1. Loosen with a box wrench or a socket and long breaker bar. To gain additional leverage, slip a long pipe or thick-walled tube over breaker bar or wrench.
2. Insert wood block **A** as shown, with grain perpendicular to blade, to prevent blade from turning when loosening.
3. Wear thickly padded gloves. Keep hands clear of blade path. Blades may rotate when bolt releases.

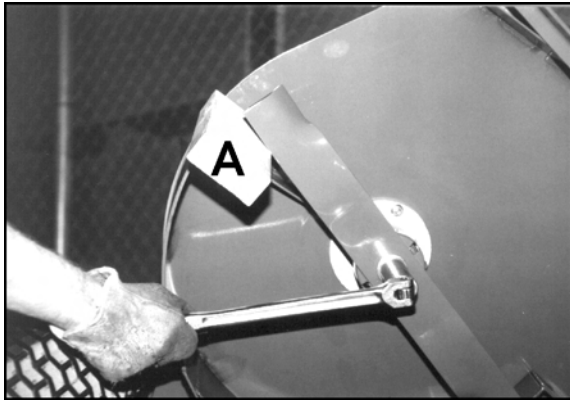

SHARPENING

Blades may be sharpened by filing or grinding.

- Inspect blades before sharpening.
- Replace bent or cracked blades.
- Replace blades when the lift portion has worn thin.
- Maintain cut angle at 30°.
- Do not overheat blades when sharpening.
- Always use Schiller Grounds Care, Inc. blades. Use of another manufacturer's blades may be dangerous.

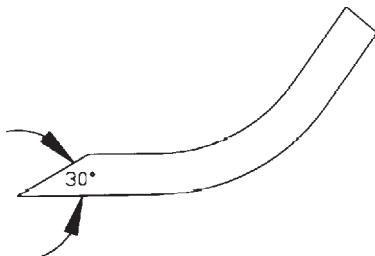

BLADE BALANCE

Blade balance must be maintained at 5/8 oz-in (19.4 g-cm) or less. Failure to keep blades balanced causes excess vibration, wear, and shortened life of most components of the machine.

To balance a blade:

1. Sharpen blade first.
2. Balance the blade at the center.
3. Attach a 1/8 oz (3.9 g) weight at a distance 5" (127 mm) from center on the light end. This should make the light end the heavy end:
 - If it does, the blade is balanced.
 - If does not, file or grind the heavy end until the addition of the weight makes the light end the heavy end.

BLADE INSTALLATION

1. Wear thickly padded gloves to prevent cuts from the sharp blade.
2. Insert the blade bolt, in order, through the conical washer (cup side toward the blade, as shown), the blade, and the blade spacer.
3. Install assembly on the blade spindle.
4. Torque the blade bolt to 70 ft-lbs.

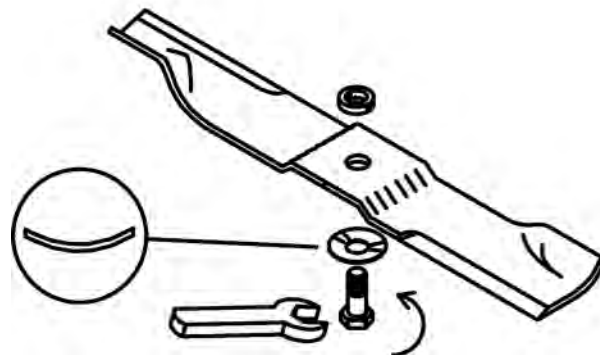

SPECIFIC TORQUES

BLADE BOLT TORQUE: 70 FT-LBS (95 Nm)
WHEEL HUB NUTS: 175 FT-LBS (237 Nm)
ENGINE CRANKSHAFT BOLT: 50 FT-LBS (68 Nm)
LUG NUTS: 75-100 FT-LBS

PREDATOR-PRO SERIES

DECK LEVELING

- Park the machine on a smooth, level surface. Raise the deck to the transport position.
- Lower the deck onto a pair of equal height blocks **A** under the rear corners of the deck. Place another pair of adjustable blocks **B** under the front of the deck so that the deck top is pitched forward 1/8".

FORWARD PITCH SHOWN

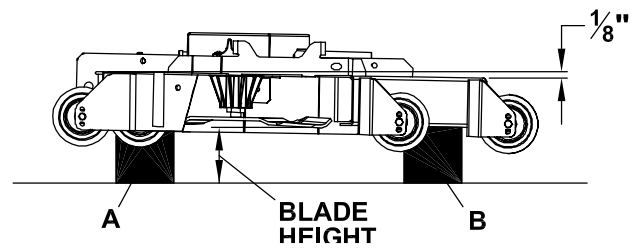

A forward pitched deck provides the best horsepower. A level deck provides the best quality of cut. A rearward pitched deck provides the best striping. Certain grass types and conditions may vary.

NOTE: The front and rear of the deck are at different heights.

- Measure the height of the blade cutting edge above the ground. Remove pin **C** and set the height of cut lever **D** to that height.
- Loosen nuts **I** at all four corners of the deck.

NOTE: This will relieve tension on chains **H**.

- Loosen the jam nuts **E** on the height of cut clips **F** and adjusting screws **G**. Turn the adjusting screws **G** until the play is taken out of the chains **H** at all four corners. Tighten the jam nuts **E** against the clips **F** and at the adjusting screws **G**. Retighten nuts **I** at this time.

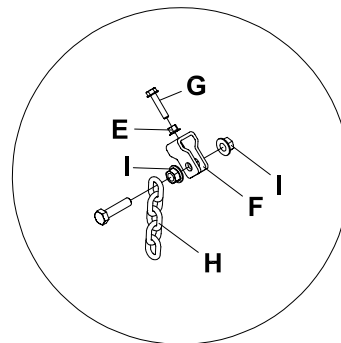
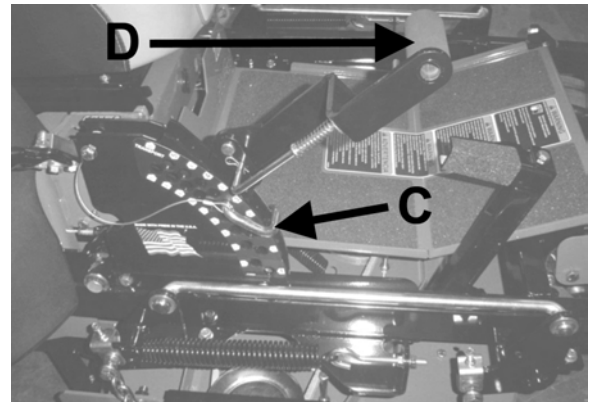

COUNTERBALANCE SPRINGS

- Raise the cutterdeck all the way.
- Adjust the spring **A** with nut **B**: The spring length should be set at approximately 8-3/4", inside loop to inside loop, when in transport position.

The springs may be tightened or loosened from this point according to personal preference.

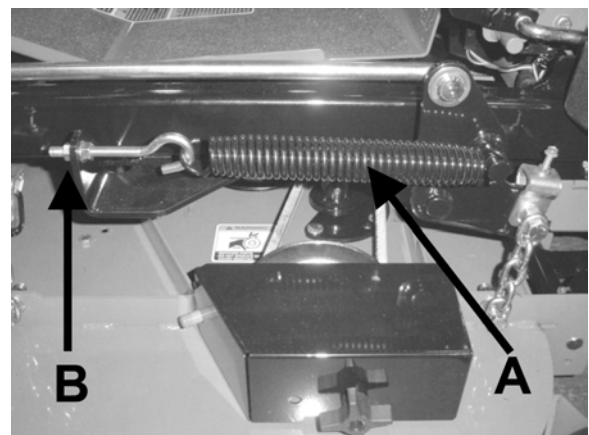

HEIGHT OF CUT

The height of cut is set by moving height of cut pin **C** to the hole designated for the height of cut desired.

To change the height of cut:

1. Lift the deck to the highest position.
2. Move pin **C** to the selected hole.
3. Lower the deck until the lift lever is stopped by the pin.

NOTES:

- Height of cut may vary due to the amount of tread on the tires, tire diameter or inflation pressure. Rear wheels 12 p.s.i.
- For best results, adjust the rear deck rollers for the height of cut to be used (see below).

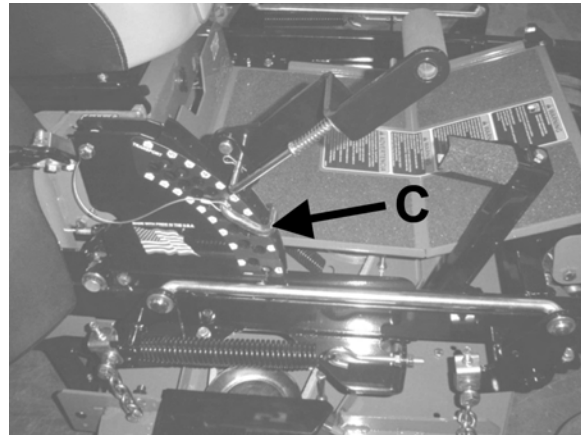

REAR DECK ROLLERS

The rear outside deck rollers are adjustable up and down to provide improved deck flotation and scalping protection at various heights of cut. They are not intended to ride continuously on the ground. Adjust no closer than 3/8" (10mm) to the ground.

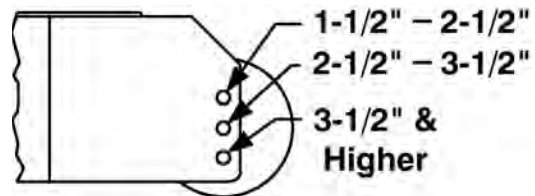

Height of cut ranges for roller adjustment

FRONT DECK LIP

Adjustable front deck lips have been provided on 52 in. and 61 in. cutterdecks for various cutting conditions.

To revise per conditions:

1. Loosen the front bolts **S**.
2. Adjust height of **H**.
3. Retighten **S** once you have desired height.

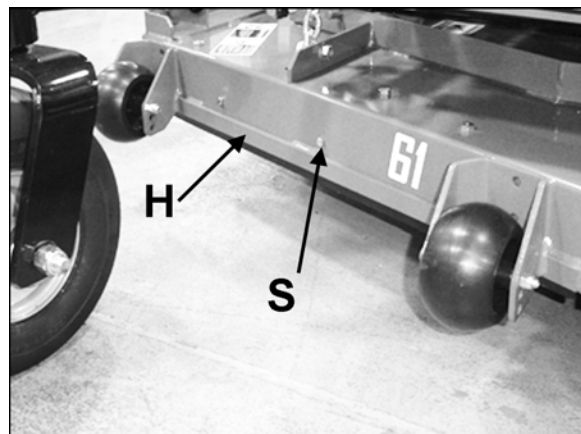

PREDATOR-PRO SERIES

CONTROL LEVERS

There are two mounting positions for the control levers, upper and lower. The lower position works well for most people. Taller operators may need the upper position.

To adjust the height of the control levers:

- Remove bolts **A** and nuts **B**.
- Align holes in control lever **D** with appropriate holes in traction lever bracket **C**.
- Install bolts **A** and nuts **B**.

The upper mounting hole for the control levers is slotted to allow fore-aft adjustment and to allow alignment of the levers.

To adjust or align the control levers:

- Loosen nuts **B**.
- Adjust control lever position.
- Tighten nuts **B**.

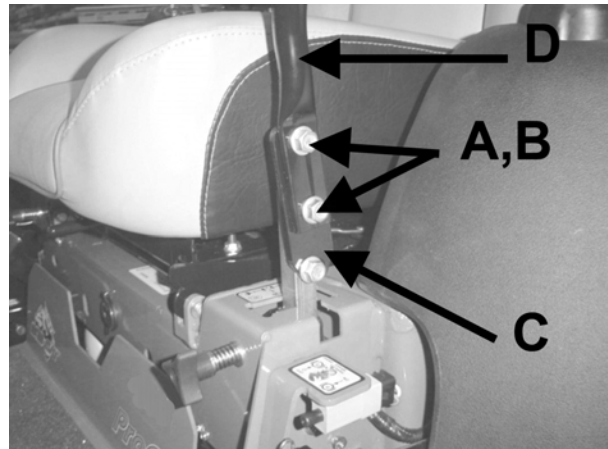

PARKING BRAKE

Park machine on a smooth level surface.

Support the machine with the rear wheels off the ground, using jack stands or equivalent. **DO NOT** rely on mechanical or hydraulic jacks.

1. Remove rear wheels.
2. Measure spring length **O** with parking brake **N** in the OFF position.
3. Move parking brake **N** to the ON position and measure length of spring **O** again. When spring deflects 3/8" it is properly adjusted.
4. If adjustment is required, return parking brake **N** to the OFF position.
5. Disconnect one end of rod **M** at the brake and loosen jam nut.
6. Adjust rod **M** in or out as required until 3/8" deflection in brake spring **O** is achieved with parking brake **N** in the ON position.
7. Reconnect rod **M** and retighten jam nut.
8. Repeat steps 2-7 on opposite side of machine.
9. Replace wheels and tighten wheel nuts.

NOTE: Parking brake must be in the OFF position to properly seat brake drums.

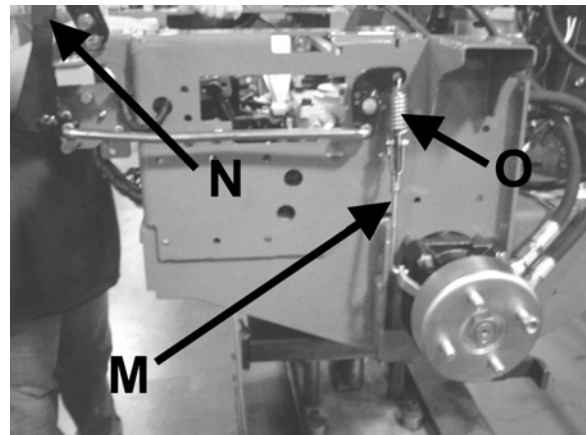

Parking brake assembly (tire and deck not shown for clarity - brake in ON position).

This adjustment will cause the brake springs to stretch 3/8" when the parking brake is in the ON position, providing the correct parking brake force without overloading the brake arm.

HYDROSTAT ADJUSTMENTS

A turnbuckle-style hydrostat neutral adjustment is provided.

Neutral:

1. Support the machine with the rear wheels off the ground. Use jackstands or equivalent support. Do not rely only on mechanical or hydraulic jacks.
2. Move the traction levers out into the neutral lock position and raise the seat.
3. Disconnect the seat switch wire **K** and temporarily connect the two terminals with jumper wire **J** as shown.
4. Start the engine and run at low speed.
5. Loosen jam nuts **T** at both ends of the control rod.
6. Rotate the control rod until the corresponding wheel stops turning. Lock the jam nuts. Run the engine up to high idle to check the adjustment. Readjust if necessary.
7. Repeat steps 5 and 6 for the opposite side.
8. Remove the jumper wire **J** and reconnect the seat switch.

Reverse Return:

1. Move traction levers out to the neutral lock position and raise the seat.
2. Locknut **U** should be run on the bolt as far as it will go.
3. Loosen jam nut **Y**. Adjust the clevis yoke by turning the head of the bolt until the clevis pin just makes contact with the rear of the slot in the lever it connects with. Tighten jam nut **Y**.
4. Repeat steps 2 and 3 for the opposite side.

NOTE: A slight creep in reverse is acceptable provided the wheel does not turn and the hydrostat pump does not whine when the parking brake is on.

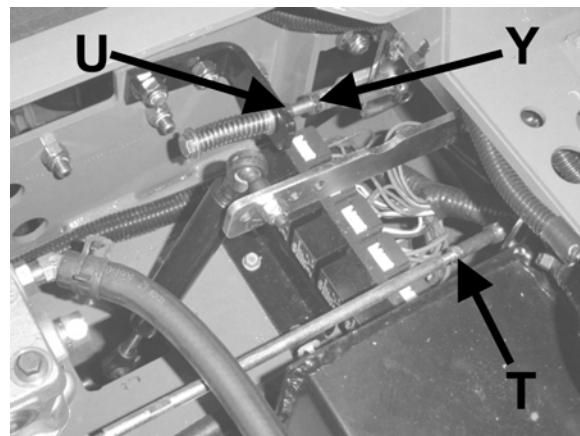
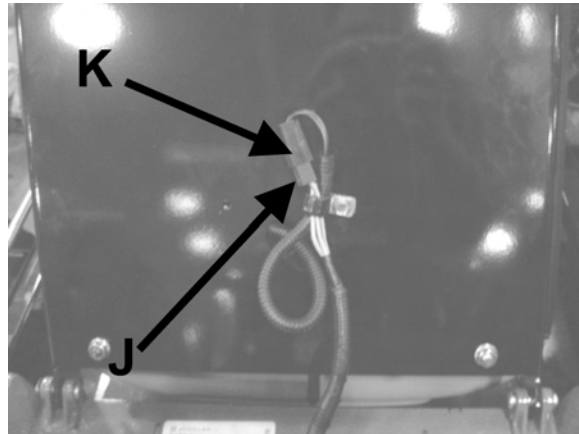

Right side adjustments

PREDATOR-PRO SERIES

CUTTERDECK BELT

1. Tilt floorplate all the way forward.
2. Set the cutterdeck in a middle height-of-cut position.
3. Use a 3/8" ratchet and extension to back tensioning idler off to remove belt from idler. Remove belt from cutterdeck pulleys.

NOTE: Use the 3/8" ratchet in the square hole **A** on the idler.

4. Remove belt from clutch pulley.
5. Install the new belt by performing these steps in reverse order.

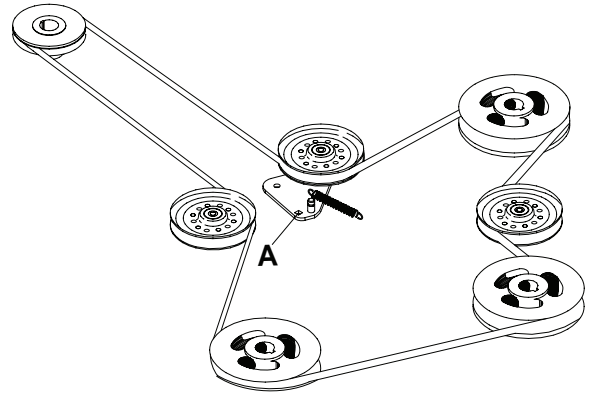

Note: Always use BobCat. replacement belts, not general purpose belts. BobCat belts are specially designed for use on commercial mowers and will normally last longer.

TRACKING HANDLES

An adjustment is provided to allow the operator to align the control levers with each other during operation.

1. Turn knob **W** clockwise to shorten control lever travel.
2. Turn knob **W** counter-clockwise to increase control lever travel.

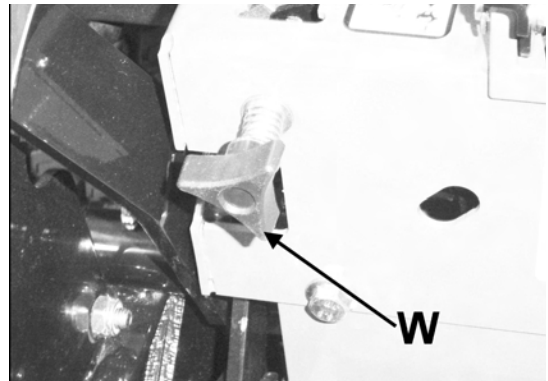

DAMPERS

Different damper mounting holes have been provided for various operator preferences with control lever motion.

1. For a stronger resistance feel, mount the dampers **X** in the outer most hole **Z** of the motion control weldment.
2. For a lighter resistance feel, mount the dampers **X** in the inner most hole **V** of the motion control weldment.

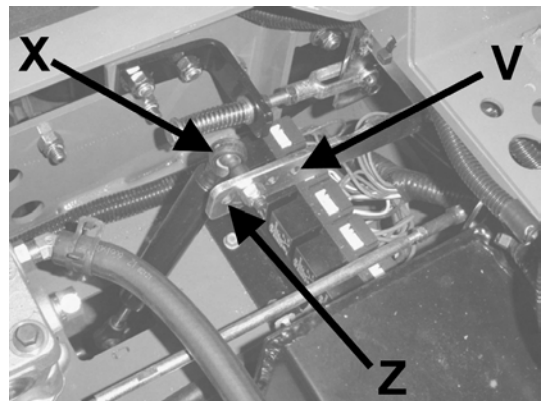

PUMP-DRIVE BELT

1. Remove engine-cutterdeck belt (see engine-cutterdeck belt replacement).
2. Attach an extension to a 3/8" drive ratchet. Insert the ratchet extension in the square hole of the pump drive idler arm. Use the ratchet handle to rotate it enough to remove the pump drive belt.
3. Install a new pump drive belt in the same manner as it was removed.
4. Re-install engine-cutterdeck belt (see engine-cutterdeck belt replacement).

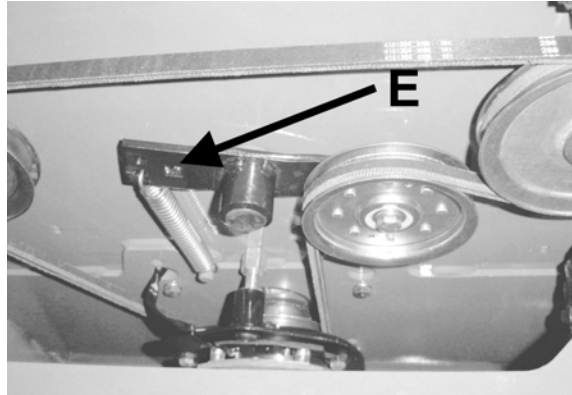

SCHILLER GROUNDS CARE, INC.
ONE BOB-CAT LANE
P.O. BOX 469
JOHNSON CREEK, WI 53038
920-699-2000
www.schillergc.com



©Schiller Grounds Care, Inc. 2010